



**REMECURE**

*Formulated in Denmark*



**REMECURE**

*Formulated in Denmark*

**FACTORY PORTFOLIO**

CAPSULES



TABLETS



SOFTGELS



BOTTLES



  
**REMECURE**  
*Formulated in Denmark*

BLISTERS



LIQUIDS



POWDER



YOUR  
BRAND





# CAPSULES



### 1 Capsules

- Vegetarian (Vegan)
- Gelatine
- Delayed release
- Without Titanium Dioxide

This capsule holds **290 to 575 mg** of powder.\*

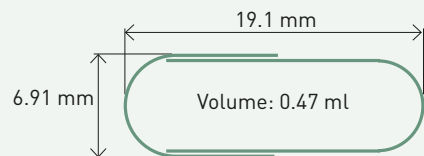

### 0 Capsules

- Vegetarian (Vegan)
- Gelatine
- Delayed release
- Without Titanium Dioxide

This capsule holds **400 to 805 mg** of powder.\*

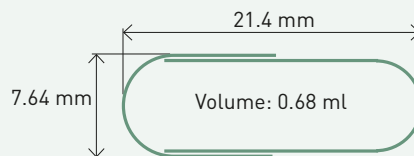

### 00 Capsules

- Vegetarian (Vegan)
- Gelatine
- Delayed release
- Without Titanium Dioxide

This capsule holds **500 to 1140 mg** of powder.\*

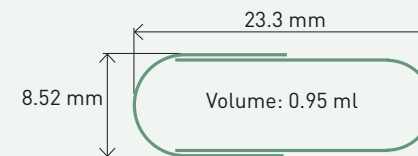

Available in different colours and materials. \*Depending on the granulometry of the content.



# TABLETS



**16 x 8 mm**  
**Oval-shaped**  
flat

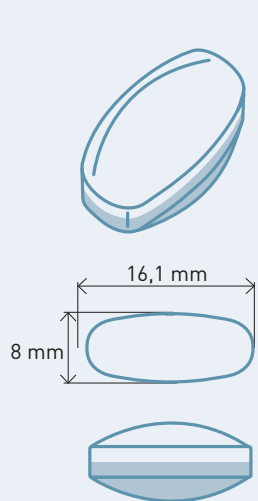

**19,1 x 8.5 mm**  
**Oval-shaped**  
flat

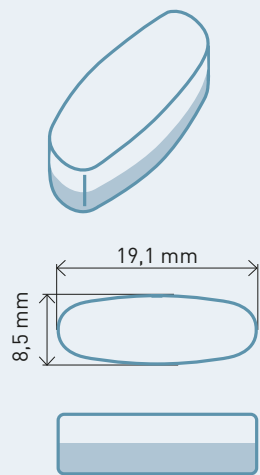

**22.4 x 8.5 mm**  
**Oval-shaped**  
flat

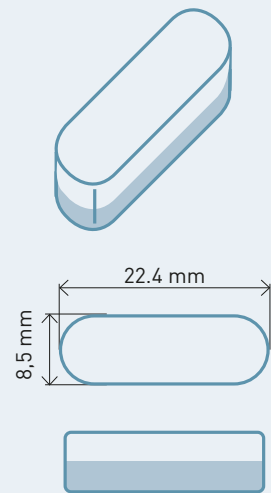

**Ø 7 mm**  
**Round**  
Tablet



**Ø 10 mm**  
**Round**  
Tablet

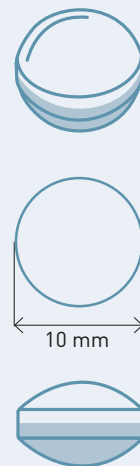

**Ø 10.5 mm**  
**Round**  
Tablet



**Ø 20 mm**  
**Round**  
Tablet  
(With cross)



**Ø 25 mm**  
**Round**  
Tablet

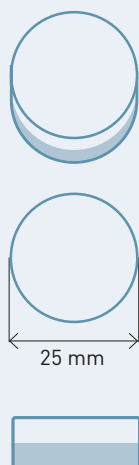

All tablet formats can also be made in BILAYER.



# SOFTGELS





**VEGETABLE shell  
4 Round**

- Tapioca



Aprox. 200 mg

**VEGETABLE shell  
10 Oval**

- Tapioca



Aprox. 500 mg

**ANIMAL shell  
Oval 3**

- Bovine
- Fish



Aprox. 180 mg

**ANIMAL shell  
Oval 6**

- Bovine
- Fish



Aprox. 320 mg

**ANIMAL shell  
Oval 10**

- Bovine
- Fish



Aprox. 500 mg



Ask us  
for  
**bespoke  
formats.**



**ANIMAL shell  
Oval 12**

- Bovine
- Fish



Aprox. 660 mg

**ANIMAL shell  
Oblong 20**

- Bovine
- Fish



Aprox. 1000 mg

**ANIMAL shell  
Oblong 22**

- Bovine
- Fish



Aprox. 1200 mg

**ANIMAL shell  
Oblong 24**

- Bovine
- Fish



Aprox. 1300 mg

Available in  
different colours,  
coatings and  
finishings.



# BOTTLES



75 to  
500 cc  
**PET** and  
**HDPE**  
bottles.



**PET**



**Glass**



**Biodegradable**



With **screw cap**  
and **induction seal**.

Bottles  
and caps are  
available in  
different  
**colours**.

**Biodegradable**  
packaging line.



# BLISTERS



### Capsules 0/00

10 units.

#### Format 0:

73x97x8.2 mm

#### Format 00:

73x97x9.3 mm

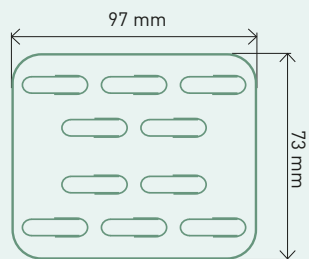

### Capsules 0/00

15 units.

#### Format 0:

73x97x8.2 mm

#### Format 00:

73x97x9.3 mm

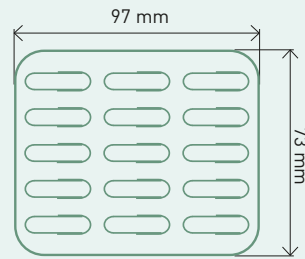

### Softgels

15 units.

#### Format Oval 10:

73x97x9.3 mm

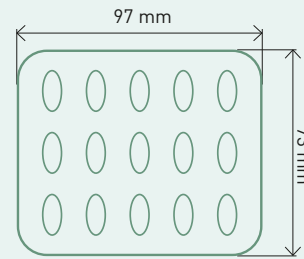

We can produce  
**15 unit**  
blister in  
**Tablets**



**Multiproduct!**



### Capsules 0/00

30 units.

**Format 0:** 150x97x8.2 mm

**Format 00:** 150x97x9.3 mm

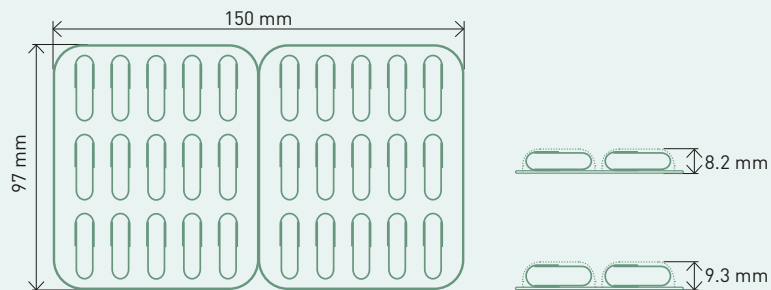

### Capsules 0/00

20 units.

**Format 0:** 150x97x8.2 mm

**Format 00:** 150 x97x9.3 mm

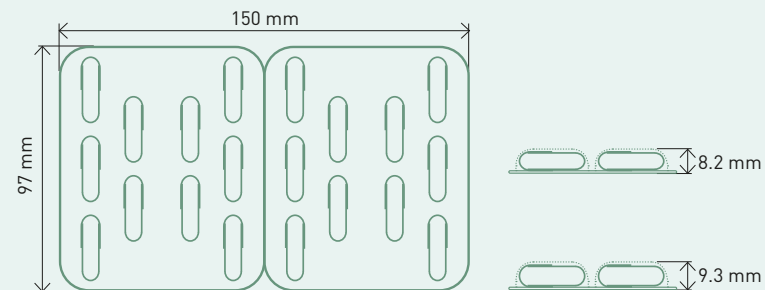

We can pack **combinations** of capsules, **softgels** and **tablets** in the same blister-pack.



**Tablets 22.4 x 8.5 mm**  
15 units.

**Format Oval-shaped**  
flat: 73x97x6.5 mm

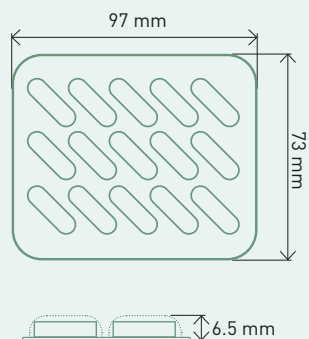

**Tablets 19,1 x 8.5 mm**  
15 units.

**Format Oval-shaped**  
flat: 73x97x6.5 mm

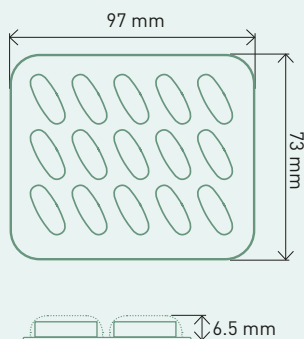

**Tablets Ø 10 mm**  
15 units.

**Format Round:**  
73x97x6.5 mm

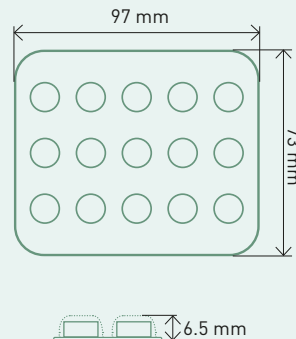

**Tablets Ø 7 mm**  
30 units.

**Format Round:**  
73x97x3.5 mm

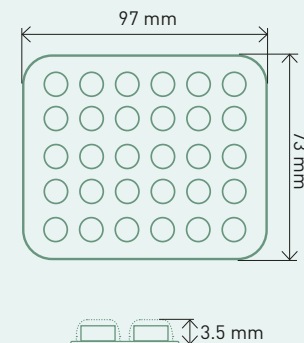



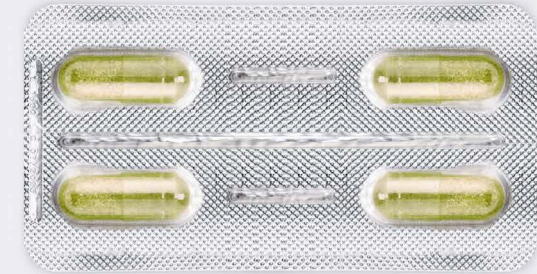

Possibility  
to **combine  
different  
formats** in  
one unique  
blister-pack.

We can pack  
**combinations** of capsules,  
**softgels** and **tablets** in the  
same blister-pack.

## NEW SAMPLE FORMATS

### Capsules 0/00

4 units.

**Size:** 86x43x8.9 mm

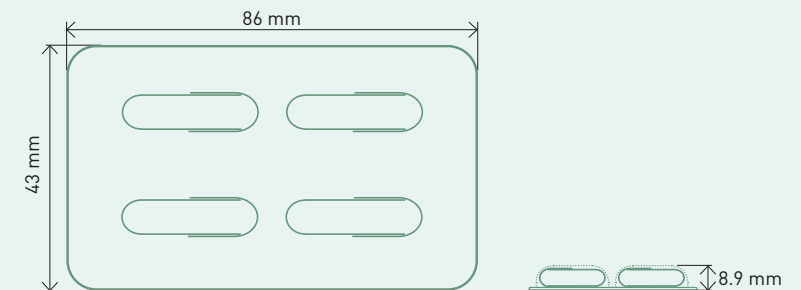



# LIQUIDS



**Vials**  
30 ml white and  
green **PET** vials.



**Vials**  
25 ml amber  
skinny **PET**  
vials.



**Vials**  
10 ml amber  
**PET** vials.



**Sticks**  
Custom  
screen printing  
in a **variety of**  
**lengths.**



Bottles  
available  
from **50ml**  
to **1L**, also  
transparent.



**Syrups**  
125 ml amber  
**PET** bottles.



**Syrups**  
150 ml amber  
**PET** bottles.



**Syrups**  
200 ml amber  
**PET** bottles.

Ask us for more  
formats.



# POWDER



### Simple sachets

in three sizes:

**50x70 mm.**

Capacity between **3-6 g.**

**70x90 mm.**

Capacity between **6-12 g.**

**90x120 mm.**

Capacity between **10-20 g.**

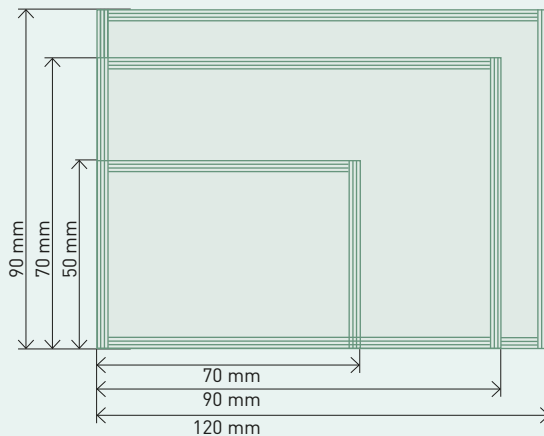

All sachets have **aluminum** and are **heat-sealed**.

### Double sachets

in two sizes:

**100x70 mm.**

Capacity between **3-6 g.**

**140x90 mm.**

Capacity between **6-12 g.**

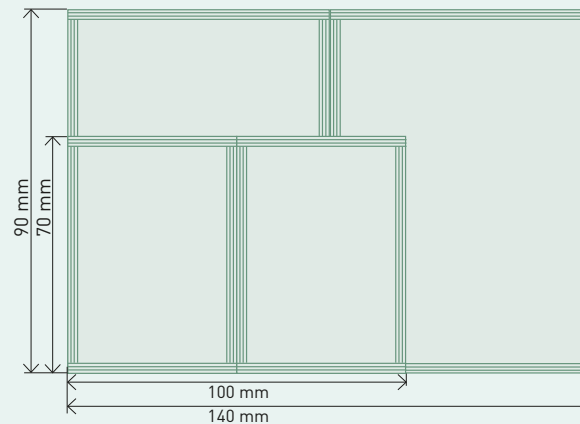

All sachets have **aluminum** and are **heat-sealed**.

### Containers

Metallic containers for powdered food products.

Also available in **cardboard**, **PET** and **HDPE**.





# MINIMUM ORDER QUANTITY



Capsules	200,000 units
Tablets	150,000 units
Softgels	150,000 units
Syrups	5,000 units
Vials	30,000 units
Sachets	60,000 units
Containers	3,000 units



## Germany

**Address:** Birnbaumsmuehle 65  
15234 Frankfurt (Oder)

Tel. +(49) 033-566-594777  
+(49) 033-566-594664  
[info@remecure.com](mailto:info@remecure.com), [www.remecure.com](http://www.remecure.com)

## Europe

**Address:** Dronninggaards Alle 69,DK –  
2840 Holte, Denmark

Tel. +(45) 916-573-25  
[info@remecure.com](mailto:info@remecure.com), [www.remecure.com](http://www.remecure.com)

---

## Middle East

**Address:** Burlington Tower, Business Bay,  
Dubai, United Arab Emirates

Tel. +(97) 155-896-9972  
[info@remecure.com](mailto:info@remecure.com), [www.remecure.com](http://www.remecure.com)